

JUMA PA1000

Linear Amplifier

User Manual



Congratulations!

We are happy that you have selected the JUMA PA1000 linear amplifier.
You will find it easy to use. Enjoy using your JUMA PA1000.

Safety warnings!

Dangerous voltage inside JUMA PA1000.

Do not open the enclosure.

Check that your mains AC voltage is the same as marked on the rear panel. If you have ordered a switchable 115/230VAC option check that you have selected the correct mains voltage with the selector on the bottom of case.

Use a AC mains socket with a protective earth.

If a mains protective earth is not available connect your station ground to the rear panel ground terminal.

If you need to change the mains fuses switch OFF the power with the rear panel rocker switch and remove the mains cable from the power entry module and wait at least 5 minutes before fuse change.

Cautions!

Set input power to 10W! NEVER drive more than 25 watts RF to the TRX input connector.

Some transceivers may transmit up to 100 W for a short time although you have selected 10 W output. To avoid MOSFET failure keep the EXCITER MAX PWR setting at 100W until you are SURE that your transceiver is not momentarily transmitting more than selected. This will limit the max gain setting (Gx). See settings instructions.

Please understand that any antenna tuner which is specified for 1kW or more CAN NOT stand 1kW power with an unknown SWR. If the SWR is high enough the RF current or the RF voltage can exceed the limits of the tuner components. This may end up to a break or arcing in the tuner which may cause a dangerous flyback energy to the amplifier. Please check the power/SWR limitations of your tuner. If the SWR limitations are not specified for your tuner do not use such a tuner. Typically high power tuners are limited to match antennas with SWR 1:3 or better. This means that you must know your antenna SWR without a tuner. **A reasonable matched resonance antenna is highly recommend instead of using an antenna tuner!**

Any antenna tuner, roller or relay based tuners, especially auto tuners, should be preadjusted at the lowest practicable RF power to avoid a dangerous flyback voltage to the amplifier. Warranty is void if you break your JUMA PA1000 amplifier by tuning an antenna tuner when JUMA PA1000 amplifier in OPER state. This applies to all tuners. **TUNE WITH EXCITER LOW POWER AND DISABLE AUTO TUNE FOR JUMA PA1000 USE!**

JUMA PA1000 can stand any antenna SWR and will safely go to the SWR protection if there is not breaking parts between the amplifier and the antenna. **WE RECOMMEND NOT TO USE AN ANTENNA TUNER** but adjust your antenna to a reasonable SWR.

Precautions!

JUMA PA1000 has been designed for SSB and CW operation. It is not designed for 100 % duty cycle key-down operation which is likely to happen in FM, AM, RTTY and digital modes. PA1000 will go to temperature protection during long key-down periods. Avoid long key-down periods by following the temperature indication. Select Low PA voltage for for reduced power below 700 W.

Manual band selection is NOT recommended because you may end up to a low output power with wrong band selection and then accidentally overdrive the amplifier. **A band data cable for your transceiver and AUTO BAND selection is highly recommended.**

If the antenna is not properly matched you may not get full power output. SWR better than 1:1.5 is recommended. If the SWR is approaching 1:2 you may need to lower the amplifier gain or reduce drive level.

Copyright

JUMA PA1000 is designed in Finland by OH2NLT and OH7SV
JUMA® is a registered trademark of Juha Niinikoski and Matti Hohtola.

All rights reserved. Copyright jumaradio.com



JUMA PA1000 overview

JUMA PA1000 is a very light weight solid state 1 kW linear amplifier for HF and 6 meter bands. JUMA PA1000 is using a most modern LDMOS transistor in the RF amplifier. The RF matching is based on novel design which provides very good efficiency. The power supply is also latest technology, a light weight resonance power supply. JUMA PA1000 accepts band data from popular transceivers. It supports parallel BCD, serial band data and analog band voltage. The band can also be selected manually.

JUMA PA1000 is fully protected against excessive SWR, over current and over temperature. It withstands wrong antennas, accidental open or short circuit in the RF output. The SWR protection is based on reverse RF power coming back from antenna. Thus if your antenna SWR is too high you can continue working by lowering the power.

Simple user interface

JUMA PA1000 is easy to use. There are only the necessary push buttons in the front panel. The LCD indicates the essential information, the LED bar shows the output power and reverse power. OPER, AUTO band and protection are indicated by their own LEDs. Rear panel has mains connector, TRX connector, ANT connector, PTT input and band data input. Firmware update is easy with a built in boot loader and with a PC.

Features

- Nominal output power 1000 W PEP
- All HF bands including WARC bands and 50 MHz
- Input power: Adjustable gain for 5 W...25 W drive
- Input SWR better than 1 : 1.3 on all bands
- Mains 230VAC or selectable 115/230VAC on request
- LCD display for band, gain, SWR, voltage, current and temperature
- LED bar display for forward and reverse RF power
- SWR, over current and over temperature protection
- Temperature controlled user adjustable proportional fan speed
- Auto band or manual band selection
- Band data formats: BCD, RS232, C-IV and voltage
- Converts serial, voltage or manual band data input to BCD band data output. Convenient feature for antenna switching etc applications.
- Remote support with the Windows application. See more here www.jumaradio.com/juma-pa1000
- Small size: W x H x D 261 x 135 x 300 mm
- Very light weight: 5.5 kg

JUMA PA1000 front panel

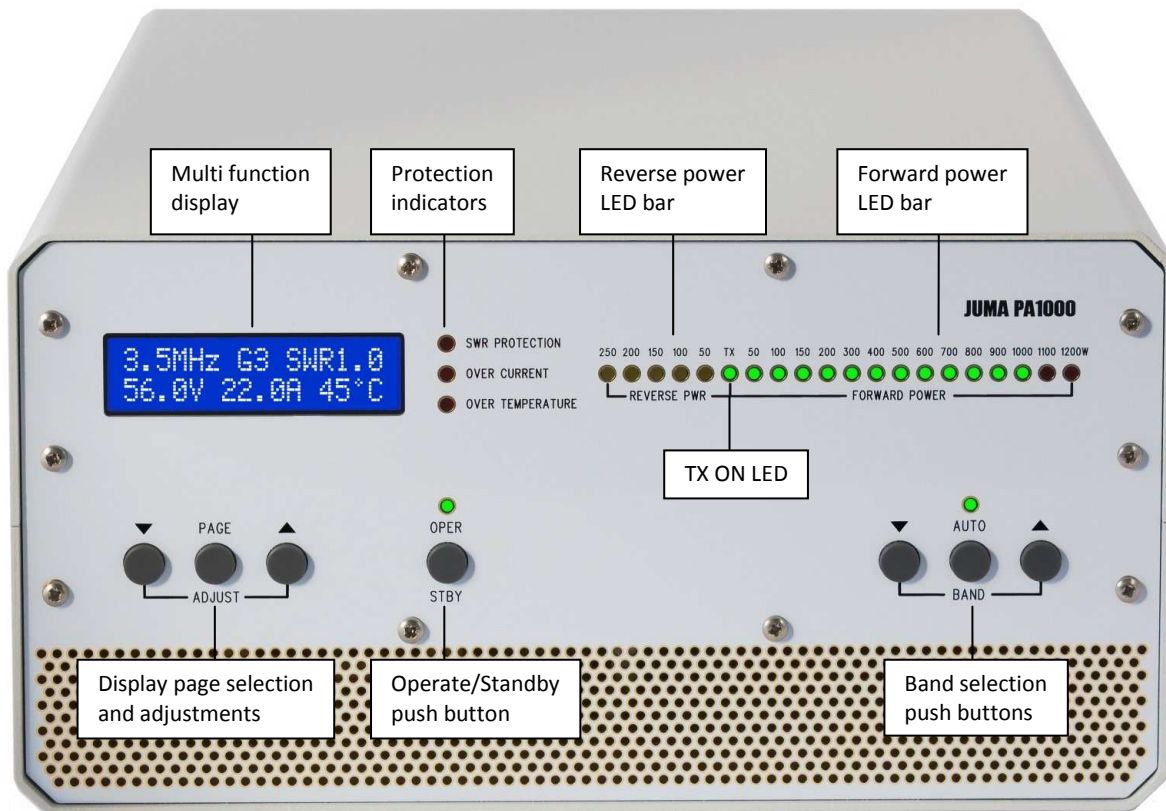

JUMA PA1000 rear panel

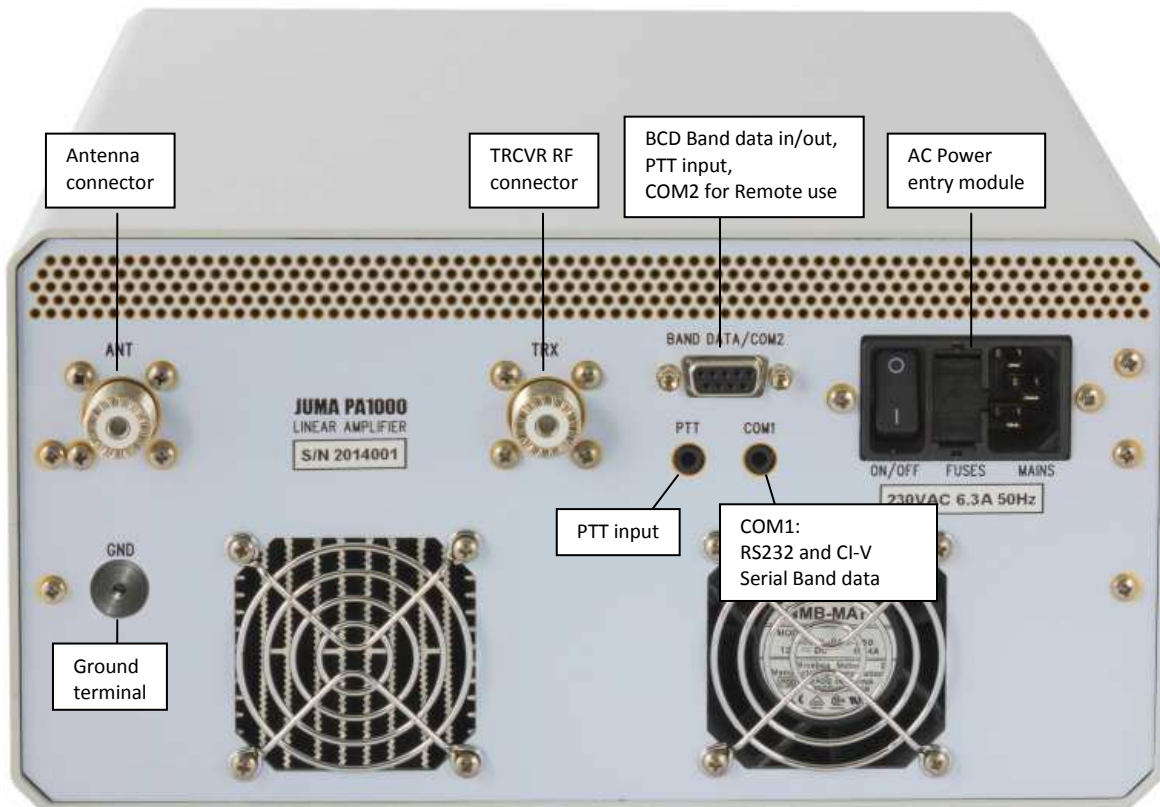

Display page selection and adjustments



PAGE button selects display page one after another. ADJUST buttons change the setting on the selected page.

Main Page

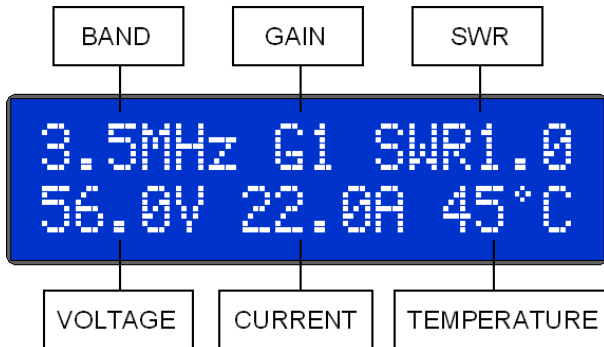

In the Main Page the ADJUST buttons are changing the gain of the amplifier by means of the adjustable input attenuator. The gain can be set from G1 to G8 with a step of 1dB. Always start with G1 which is the lowest gain by monitoring the LED bar power indicator. The gain setting is individual for each band. PA1000 will remember the gain settings. Note. EXCITER MAX PWR setting may limit the max gain setting.

Note. The temperature reading is indicating the MOSFET case temperature. The temperature rise of the heatsink is about half of that temperature rise. Max MOSFET case temperature is 105°C.

Other display pages

Push the PAGE button one after another for the other display pages and use the ADJUST buttons to change the setting.



LCD brightness adjustment



LCD contrast adjustment



Band data selection. Options: BCD data, JUMA Serial, Icom CI-V, Kenwood Serial, Elecraft Serial, Yaesu Voltage, Icom Voltage.



COM1 baud rate adjustment (Serial Band Data)



COM2 baud rate adjustment (Serial Remote data)



Fan control adjustment. The fan will run with maximum RPM at the selected MOSFET case temperature. In heavy use you can lower this setting for proactive cooling. In light use you can increase this setting.



Defines the max power level of your transceiver. Options are: 5W, 10W, 25W, 50W, 100W. This setting protects the MOSFET gates by limiting the max gain setting (G1...G8). Reduce this setting only if you are SURE that your transceiver is not momentarily transmitting more than selected.



The purpose of this PA voltage selection is to optimize the efficiency. The options are High and Low. Select Low PA voltage for for reduced power operation below 700W. Note. The voltage indication may fluctuate during standby which is normal.

LED Bar Power Indicator



The LED bar RF power indicator gives a real time view of forward and reverse power. It is indicating the peak power. The LED bar hold time and the decay speed can be adjusted in the service page if desired.

Protection indicators



The protection is implemented in the hardware and therefore it is independent of the software latency and operation. When a protections situation is detected JUMA PA1000 will go to stand-by state.

SWR PROTECTION LED will be lit if the reverse power limit is exceeded. In this case check antenna, reduce PA1000 gain or reduce exciter drive.

OVER CURRENT LED will trip if the MOSFET current 30A is exceeded. In this case reduce the gain (Gx) or reduce the drive. You can monitor the current in the LCD. Nominal current for full power is approximately 24A. The nominal bias current without drive is 2A \pm 0.2A.

OVER TEMPERATURE LED will be lit if the MOSFET case temperature 105°C is exceeded. In this case reduce power. Over temperature led will go off when the temperature has fallen below the threshold level. However amplifier will stay in STBY state until you clear it by pushing OPER button.

After you have checked the protection situation clear it by pushing the OPER button.

OPER / STBY button

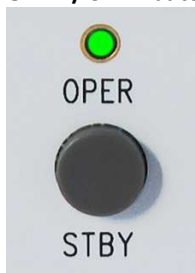

Simply push OPER/STBY button to switch between operate and standby state. LED is ON in operate-state. In start-up the default state is STBY. This can be modified in the service pages so that PA1000 will memorize OPER/STBY state for the next start-up.

Band selection buttons



Push AUTO button for automatic band selection. Green LED will be ON and the main display is showing the band. If a valid band data is not available the main display is showing “?? MHz” and PA1000 will not operate. In this case check band data cable, band data setting and the baud rate setting of the COM1.

Manual band selection is made by first pushing the BAND button which after you can select the band by pushing ▼ and ▲ buttons.

In manual band selection there is a special “AllMHz” band which indicates that the final low-pass filters are bypassed. Do not transmit with “AllMHz” selection without external low-pass filter because the harmonics are not filtered.

JUMA PA1000 saves the band selection mode for the next power-up.

Note. Manual band selection is not recommended because you may select wrong band before or later. Then you may accidentally overdrive and it may end up to a MOSFET failure!

Quick Guide for the first time use With Auto Band. **RECOMMENDED!**

1. Connect antenna with coaxial cable.
2. Connect transceiver with coaxial cable.
3. Connect PTT and band data cable from transceiver. You may need one or two cables depending on your transceiver. See the cable instructions. In the case of JUMA TRX2 PTT cable is not needed.
4. Adjust transceiver RF power output level to 10W.
5. Connect AC mains cable and switch on JUMA PA1000 by the rear panel switch.
6. After start-up go to the Band Data page by pushing PAGE button several times. Use ADJUST buttons to select a compatible band data format. In case of a serial band data check also the COM1 baud rate that it matches with your transceiver setting.
7. Push PAGE button several times until you are back in the Main Page (Band display left up).
8. Push AUTO BAND button. LED indicates auto band and you should see the band in the main display page. Check that PA1000 is tracking the transceiver band.
9. Push OPER button. LED indicates operate state.
10. Transmit SSB or CW with your transceiver and watch the output power LED bar.
11. Adjust PA1000 gain with ADJUST buttons in the main page (G1, G2, G3...) for desired power level on each band. Note. The max gain setting may be limited by MAX EXCITER PWR setting.

Next time use

Simply switch on PA1000 and push OPER button. JUMA PA1000 will memorize all other settings.

Warnings!

- **Set the output power to 10W-15W on ALL modes and on ALL bands in your transceiver.**
- **Antenna tuner is not recommended. But if you are using an antenna tuner, tune it with exciter low power and disable auto tune for high power.**
- **Adjust gain (Gx) with SSB or CW mode to a desired output power. Do not use AM, FM or similar modes because they may provide high power transients to PA1000.**

Quick Guide for the first time use With Manual Band. **NOT RECOMMENDED!**

1. Connect antenna with coaxial cable
2. Connect transceiver with coaxial cable
3. Connect PTT cable from transceiver. See cable instructions. In the case of JUMA TRX2 PTT cable is not needed.
4. Adjust transceiver RF power output level to 10W.
5. Connect AC mains cable and switch on JUMA PA1000 by the rear panel switch
6. Select manually correct band with BAND ▼ ▲ buttons. Main display shows the band.
7. Push OPER button (LED indicates operate state)
8. Transmit SSB or CW with your transceiver and watch the output power LED bar.
9. Adjust PA1000 gain with ADJUST buttons in the main page (G1, G2, G3...) for desired power level on each band. Note. The max gain setting may be limited by MAX EXCITER PWR setting.

Next time use

Switch on PA1000, check the band and push OPER button. JUMA PA1000 will memorize all other settings.

Note. Manual band selection is not recommended because you may select wrong band before or later. Then you may end up to accidentally increase the drive and it may end up to a MOSFET failure!

Rear Panel Connectors

BAND DATA / COM2 Connector

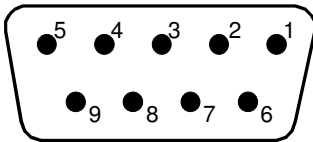

D9 female socket

BAND DATA / COM2 Connector Description

Pin #	Description
1	BCD A (Band data) *
2	COM2 RS232 OUT (Serial com output) **
3	COM2 RS232 IN (Serial com input)**
4	BCD D (Band data) *
5	GND (Signal ground)
6	BCD B (Band data) *
7	PTT IN (Parallel with PTT jack connector tip)
8	BCD C (Band data) *
9	BAND VOLTAGE (Input)

*Band data signals are pulled up to +5V with 100k resistors.

**COM2 is used for firmware updates and remote connection

BCD Band Data Table

Band	Freq	BCD D	BCD C	BCD B	BCD A
160 m	1.8 MHz	0	0	0	1
80 m	3.5 MHz	0	0	1	0
40 m	7.0 MHz	0	0	1	1
30 m	10 MHz	0	1	0	0
20 m	14 MHz	0	1	0	1
17 m	18 MHz	0	1	1	0
15 m	21 MHz	0	1	1	1
12 m	24 MHz	1	0	0	0
10 m	28 MHz	1	0	0	1
6 m	50 MHz	1	0	1	0
All band	"AllMHz"	0	0	0	0

BCD code 0000 as an input bypasses the low-pass filters and the display indicates "AllMHz".

All other input codes (1011 ... 1111) are not valid and they are indicated as "?? MHz". In that case PA1000 will not transmit.

Tip. JUMA PA1000 converts serial, voltage or manual band data to BCD output on the four BCD lines in D9 connector. This BCD output can be used to control antennas or other equipment. The output is 0V/+5V with an output impedance of 1kΩ. Thus the BCD output signals must be buffered e.g. with a BCD to Decimal decoder IC. If a band data is not available PA1000 will output BCD code 1111. If "AllMHz" is manually selected PA1000 will send BCD code 0000.

PTT in 3.5 mm jack

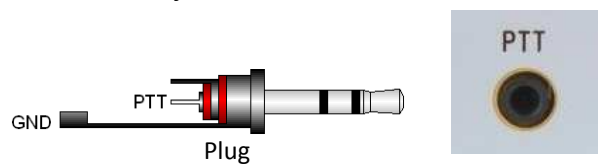

Tip is the PTT in signal and it should be grounded for transmit. PTT signal is in parallel with D9 connector pin7. PTT signal is internally pulled up to +5 V with a 4.7 kilo-ohm resistor. Current sinking requirement is 1 mA. *The ring terminal is not connected inside PA1000 so you can also use a MONO plug for PTT connector.*

In case of JUMA TRX2 transceiver the PTT cable is not needed. PTT signal is fed via the input coaxial cable.

COM1 3.5 mm jack

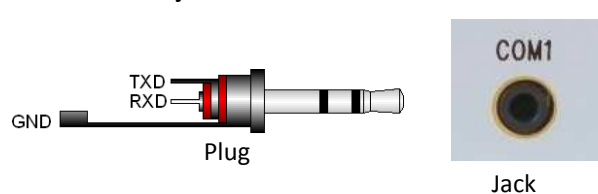

This connector is a multi-use serial com for RS232, CI-V. Tip is RXD and ring is TXD. In CI-V tip and ring must be connected together in the PA1000 end of the cable.

Note1. Do NOT connect RS232 serial outputs together.
Note2. RS232 serial output can be connected to several RS232 data inputs.

Note3. Icom CI-V open drain signals can be connected in parallel with other CI-V signals like logging software.

AC Power Entry Module



Mains power switch, 2 x fuses and mains cable socket. See the fuse value markings in the rear panel if you need to replace fuses.

Cable instructions for transceivers

JUMA TRX2 cable (RS232 band data)

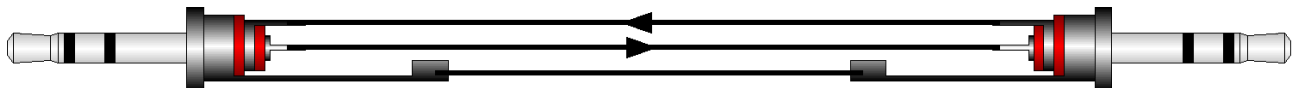

JUMA TRX2
RS232 connector

JUMA PA1000
COM1 connector
3.5 mm plug

Note1. Both ends 3.5 mm stereo plugs. A standard stereo audio cable can be used.
Note2. PTT cable is not needed. PTT signal is superimposed on RF in the coaxial cable.

ICOM CI-V cable (Band data)



ICOM
CI-V connector

JUMA PA1000
COM1 connector
3.5 mm plug

Note1. Both ends 3.5 mm plug. A mono plug can also be used in Icom end.
Note2. A standard 3.5 mm stereo audio cable can NOT be used. PA1000 end of that must be modified as shown.

ICOM PTT cable

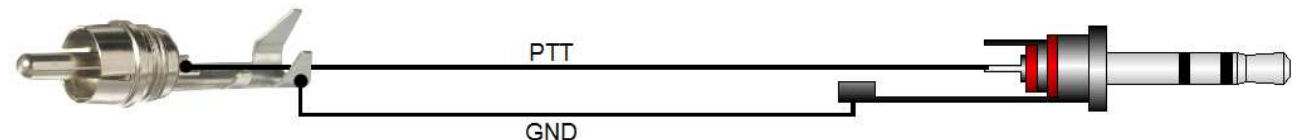

RCA plug
Marked SEND in Icom

JUMA PA1000
PTT connector
3.5 mm plug

Note. A mono plug can also be used in JUMA PA1000 because the ring is not connected inside JUMA PA1000.

Elecraft KX3 cables

KX3 RS232 band data cable

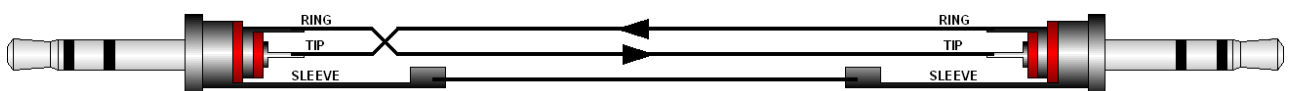

KX3 ACC1 connector
3.5 mm plug

JUMA PA1000
COM1 connector
3.5 mm plug

A standard 3.5 mm stereo audio cable can **NOT** be used as RS232 cable.

Note1. In KX3 menu set AUTOINF to ANT CTRL
Note2. Select Elecraft Serial band data in PA1000

KX3 PTT cable

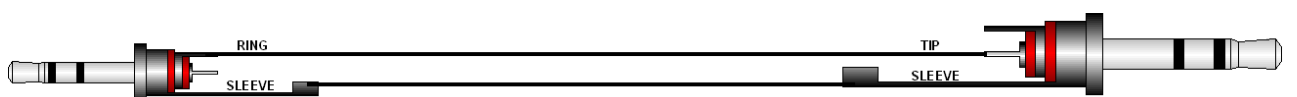

KX3 ACC2 connector
2.5 mm plug

JUMA PA1000
PTT connector
3.5 mm plug

Cable instructions for transceivers cont.

BCD band data (Elecraft K3, Yaesu and other BCD band data transceivers)

Note1. Select BCD BAND DATA in PA1000

Note2. A standard 15 pin VGA cable can NOT be modified for K3 cable because some pins are connected together inside the molded VGA connector. Make a new cable with a 15 pin and a 9 pin male D-connector plugs.

Note3. Refer to the user manual of your transceiver for BCD band data output and PTT wiring.



Elecraft K3 ACC connector



JUMA PA1000 BAND DATA connector

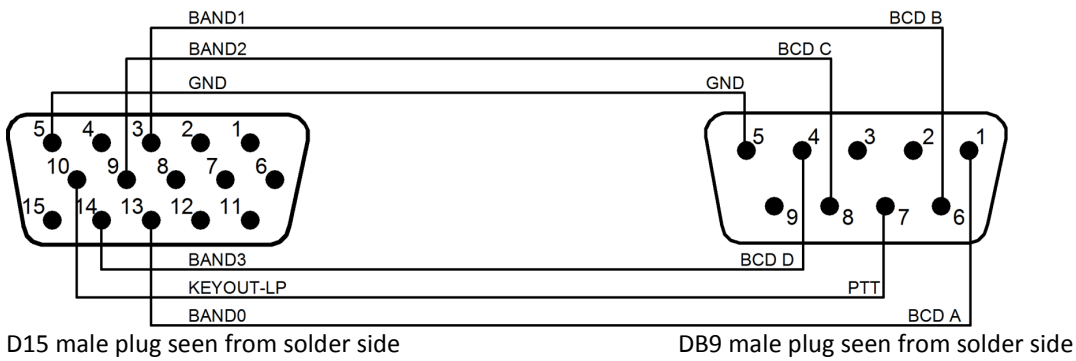

D15 male plug seen from solder side

DB9 male plug seen from solder side



Yaesu FT-1000MP BAND DATA connector



JUMA PA1000 BAND DATA connector

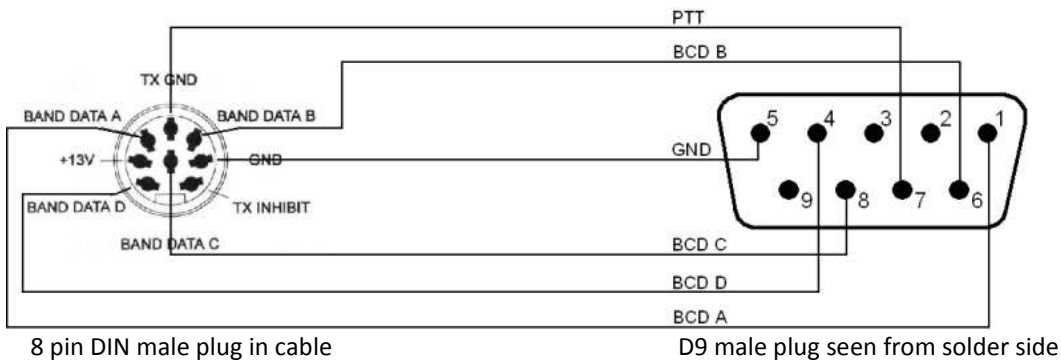

8 pin DIN male plug in cable

D9 male plug seen from solder side

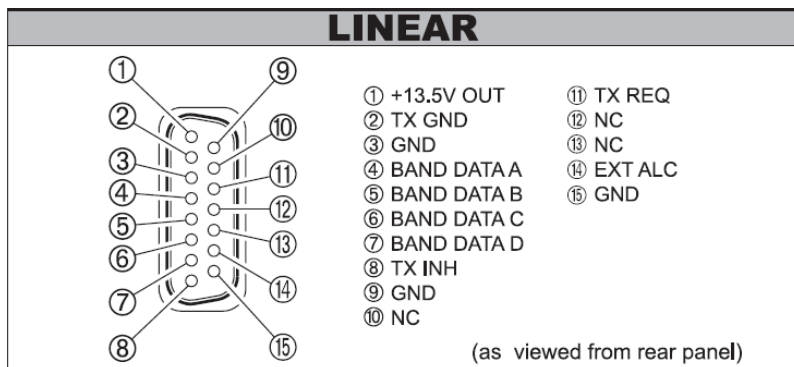

Yaesu FTDX3000 LINEAR connector. 15 pin male in cable. Follow the FT-1000MP signal names for pins 2, 3, 4, 5, 6, 7.

Cable instructions for transceivers cont.

Elecraft K3 RS232 serial COM cable

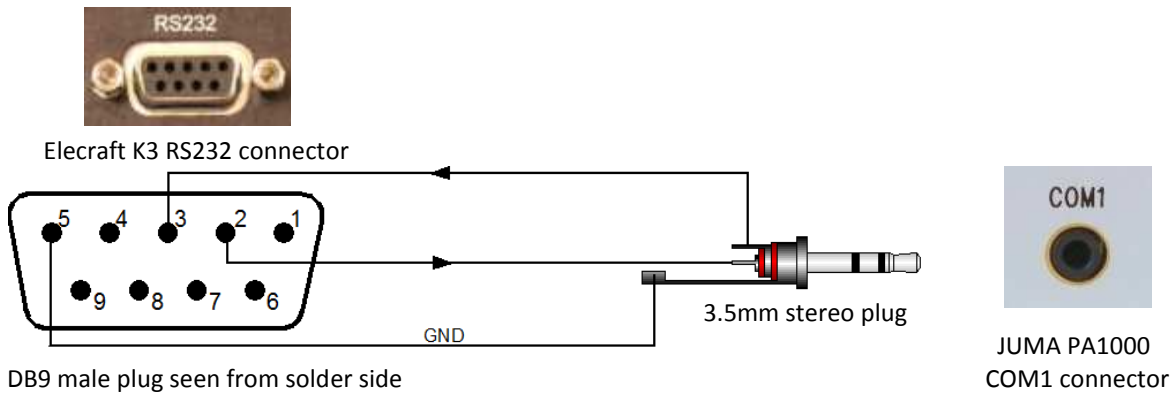

Note1. **We recommend to use BCD band data with K3 and leave COM for log etc applications.** See previous page.

Note2. Select Elecraft Serial in PA1000

Note3. Set K3 to Auto-info mode 1

Kenwood RS232 serial COM cable

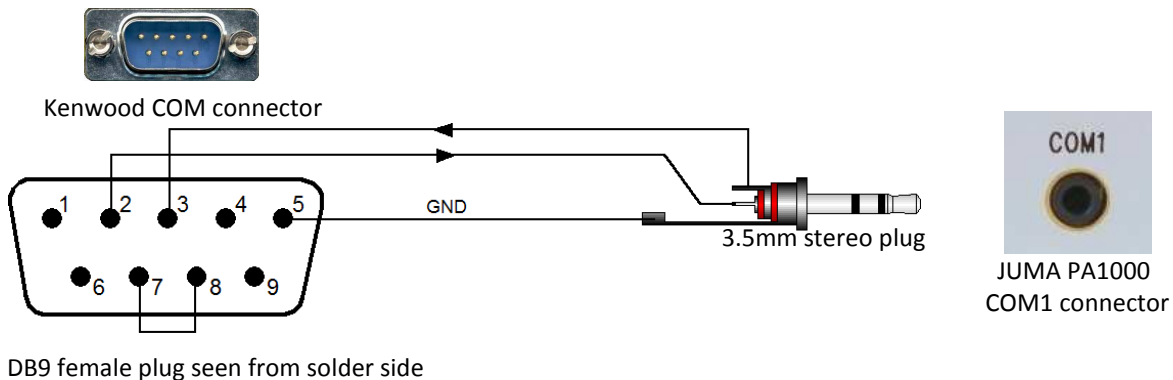

Note. JUMA PA1000 is supporting Kenwood RS232 serial band data similar to TS480 and TS2000 protocols. Select one which is compatible with your Kenwood transceiver. Kenwood is not sending band data event when the band is changed, it is polled by JUMA PA1000. To speed up the band change set PA1000 Radio Poll Rate to 500ms in the Service pages. Note also that some Kenwood transceivers need to be restarted to activate a new baud rate setting.

Additionally a PTT cable is needed. Use Kenwood REMOTE connector Pin 4 for PTT and Pin 2 for GND.

Check also Kenwood menu settings to activate linear amplifier control.

Kenwood PTT cable with 7-pin DIN connector

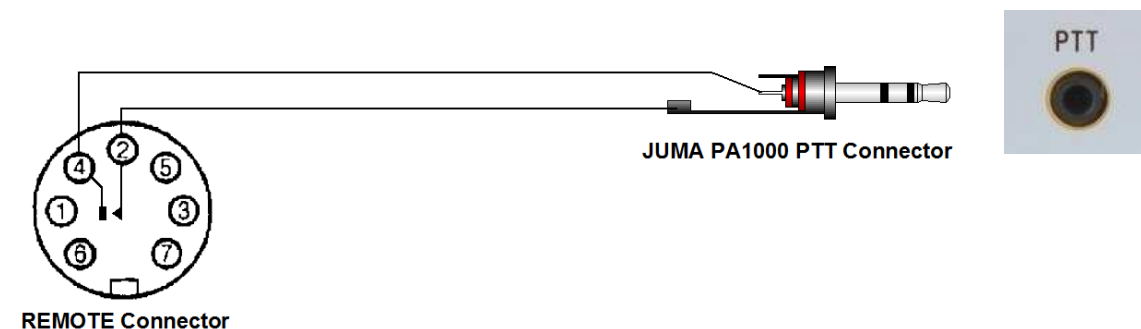

Cable instructions for transceivers cont.

Kenwood PTT cable with 8-pin MINI DIN connector

REMOTE CONNECTOR

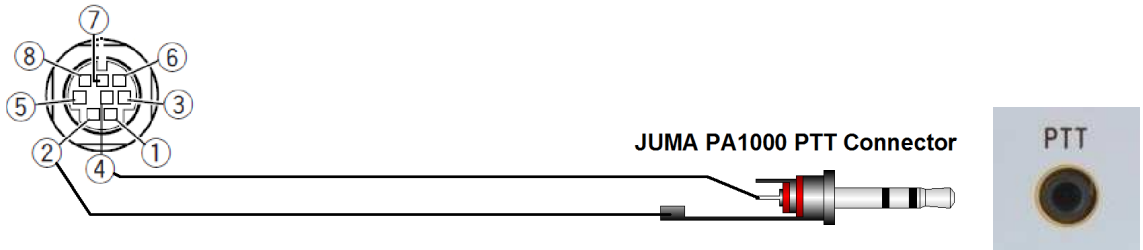

Kenwood TTL level (0V/5V) serial COM cable for TS-440, TS-450, TS-690, TS-850, TS-950 etc.

Use 6 pin DIN plug
ACC1 Connector

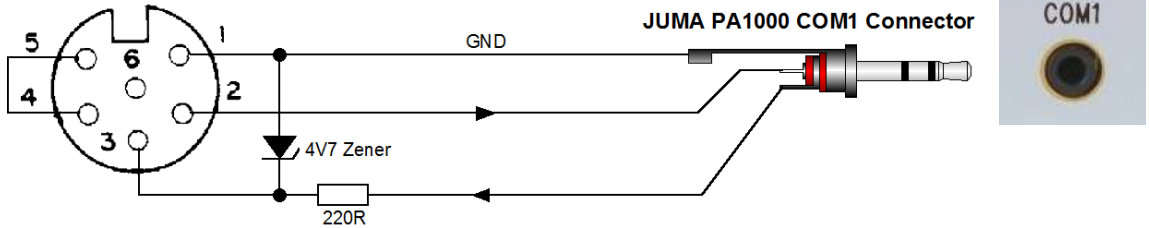

- Note1. Solder the 4.7V zener diode and the 220 ohm resistor inside the 6 pin DIN connector.
- Note2. In JUMA PA1000 **set BAND DATA to Elecraft Serial** and set the equal baud rate for both.
- Note3. Kenwood is not sending band data event, it is polled by JUMA PA1000. To speed up the band change set JUMA PA1000 Radio Poll Rate to 500ms in the Service pages.

YAESU band voltage (0...5V)

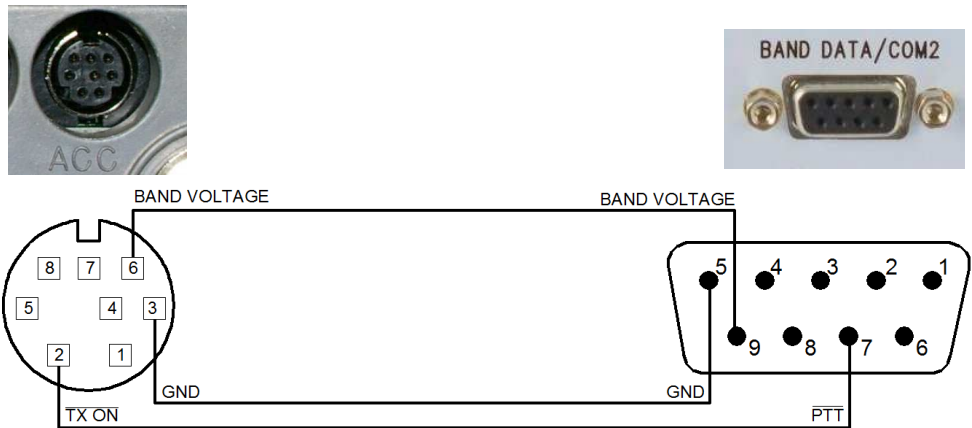

YAESU ACC connector
(FT-817 connector shown)

JUMA PA1000 BAND DATA/COM2
D9 male in cable

Yaesu Band Voltage Table

Band	Freq	Nominal voltage
160 m	1.8 MHz	0.33 V
80 m	3.5 MHz	0.67 V
40 m	7.0 MHz	1.00 V
30 m	10 MHz	1.33 V
20 m	14 MHz	1.67 V
17 m	18 MHz	2.00 V
15 m	21 MHz	2.33 V
12 m	24 MHz	2.67 V
10 m	28 MHz	3.00 V
6 m	50 MHz	3.33 V

Cable instructions for transceivers cont.

ICOM analog band voltage (0...8V)

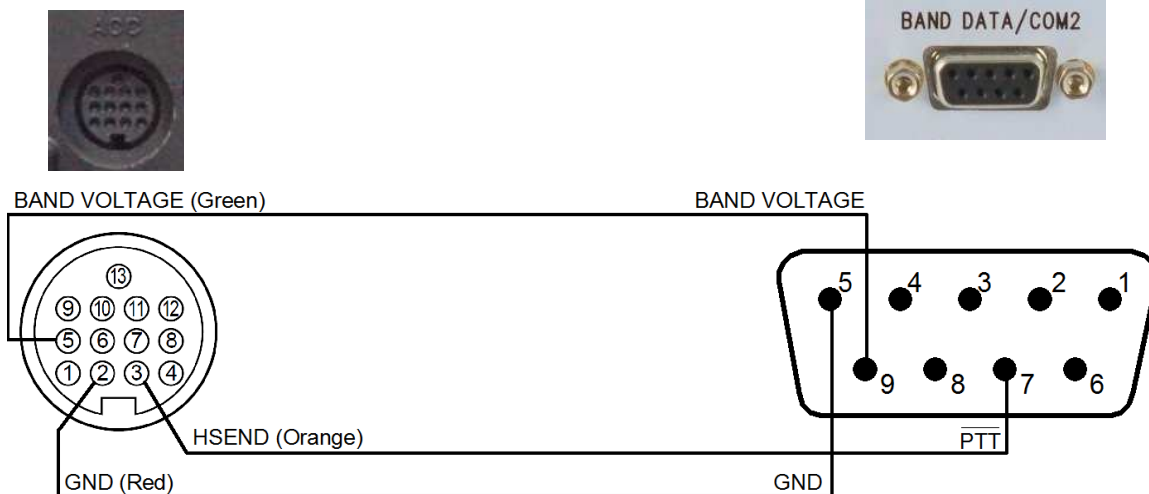

ICOM ACC connector
(IC-7000 connector shown)
See your Icom manual for correct
connector and pin order.

JUMA PA1000 BAND DATA/COM2
D9 male in cable

Note1. Icom band voltage is not supporting 50 MHz and WARC bands but 10 MHz is defined as 0 V. Zero voltage is not a proper level to verify valid band data and thus JUMA PA1000 needs 0.1 V to 1.0 V for 10 MHz selection. 50 MHz is unofficially selected at voltage 1.0 V to 2.0 V.

Note2. Some Icom transceivers need a modification to activate band voltage output. See your Icom manual.

Note3. It is recommended to use Icom CI-V serial band data instead of Icom band voltage if available.

Icom Band Voltage Table

Band	Freq	Voltage range
160 m	1.8 MHz	7.0 V - 8.0 V
80 m	3.5 MHz	6.0 V - 6.5 V
40 m	7.0 MHz	5.0 V - 5.5 V
30 m	10 MHz	0.1 V - 1.2 V
20 m	14 MHz	4.0 V - 4.5 V
15 m/(17 m)	21 MHz	3.0 V - 3.5 V
10 m/(12 m)	28 MHz	2.0 V - 2.5 V
6 m	50 MHz	1.0 V - 2.0 V

Service Pages

Service Pages are intended for advanced use, calibration and special settings. If you are not familiar with the service settings do not change anything and exit Service Pages by switching OFF the JUMA PA1000.



To enter Service Pages keep the PAGE button pressed about 5 seconds until you see text “Service pages selected”.

To exit Service Pages keep the PAGE button pressed again about 5 seconds until you see text “Main pages selected”.

Push the PAGE button one after another for each service page and use the ADJUST buttons ▼ ▲ to change the setting.

Radio Poll Rate (Default = 1000 ms, 0=No poll)

Defines the serial band data polling rate

CI-V Radio Address (Default = 00H)

Defines Icom CI-V address. See your Icom manual

COM 2 Mode (Default = Remote)

Defines COM 2 for PA1000 Remote or Service mode

Beep len, 0=OFF (Default = 50 ms)

Defines audible key beeb length. Value 0 = Sound OFF

Voltage Cal mult (Default = 10619)

Calibrates voltage reading in LCD

Current Cal mult (Default = 8000)

Calibrates current reading in LCD

Pwr Cal mult <30 MHz (Default = 1.00)

Calibrates LED bar power reading below 30 MHz

Pwr Cal mult 50 MHz (Default = 1.25)

Calibrates LED bar power reading at 50 MHz

Power FWD REV SWR (read only)

Forward, reverse and SWR reading for R&D use only

Note1.

The service settings are saved when you exit the Service Pages with a long PAGE button push.

Note2.

If you have accidentally changed calibration values in service pages you can restore factory calibration values in the “Factory cal” page.

LED Bar Hold (Default = 100 ms)

Defines the hold time for the LED bar indicator

LED Bar Decay (Default = 200 W/100ms)

Defines the decay speed of the LED bar indicator

Keep OPER state (Default = No)

By default JUMA PA1000 will

1. Start-up in STBY state
2. Go to STBY when band is changing (Firmware V1.17)

Do not change this item unless you have implemented automatic antenna switching and all your antennas are pre-tuned for each band!

BCD band bits in/out (read only)

Shows BCD band data input or BCD band data output

COM1 RX/COM2 RX (read only)

Shows received amount of bytes. R&D use only

Factory cal, Set=9 Count=0

Restores factory calibration values

Needs 9 keystrokes to avoid accidental restore

Factory defaults, Set=9 Count=0

Restores factory defaults

Needs 9 keystrokes to avoid accidental restore

Firmware programming

JUMA PA1000 firmware is easy to update. The latest firmware is available in JUMA PA1000 site. It is a HEX file with a version identification number (e.g. JUMA_PA1000_v102.hex). You can check your current firmware version in your JUMA PA1000 LCD display during start-up.

All you need is the bootloader client for Windows and a RS232 programming cable. The cable is connected to a RS232 port of your PC or via a RS232-USB adapter. FTDI model of RS232-USB adapter is recommended. See the programming cable drawing.

Quick guide for firmware programming

1. Download the latest HEX file to your hard disk
2. Connect the programming RS232 cable
3. Run the Windows bootloader client (Ingenia dsPIC Bootloader)
4. Check bootloader client COM configuration and click "configuration done"
5. Start-up JUMA PA1000 while keeping the PAGE button pushed
6. Open the downloaded HEX file into the bootloader client
7. Click the "start write" button
8. When you see "write completed" restart JUMA PA1000

The bootloader client and the latest firmware HEX file can be found here www.jumaradio.com/juma-pa1000

Firmware programming cable drawing

